



Recorder



Flow



Pressure



Temp



Analyzer



Level

Datasheet

Membrane dissolved oxygen meter

SUP-DM2800/DM3000

Supmea[®]

Committed to process automation solutions

Tel: 86-15158063876

E-mail: info@supmea.com

www.supmea.com

Membrane dissolved oxygen meter

Dissolved oxygen online controller, is widely applied for continuous monitoring and measurement of dissolved oxygen, saturation, oxygen partial pressure and temperature in the solution in the industry of thermal power, chemical fertilizer, environmental protection, metallurgy, pharmacy, biochemistry, food and water, etc.

Continuous monitoring measurement data is connected with the recorder via transmitting output to realize remote monitoring and recording. It can also be connected with RS485 portal via MODBUS-RTU protocol to access computer for monitoring and recording.

Applications

- Drinking Water Plant
- Wastewater Treatment Plant
- Chemical Plant
- Aquaculture
- Fish farming
- Environmental protection water monitoring



Features

- Module design of the circuits.
- Isolating transmitting output.
- Isolating RS485 communication.
- DO, saturation and temperature measurement.
- Air calibration.
- Manual and auto temperature compensation.
- High/low alarm.
- LCD backlight switch

SUP-DM2800

Principle

Dissolved oxygen meter Measuring principle The oxygen molecules diffused through the membrane are reduced to hydroxide ions (OH-) at the cathode. Silver is oxidized to silver ions (Ag+) at the anode (this forms a silver halogenide layer). A current flows due to the electron donation at the cathode and the electron acceptance at the anode. Under constant conditions, this flow is proportional to the oxygen content of the medium. This current is converted in the transmitter and indicated on the display as an oxygen concentration in mg/l, µg/l, or Vol%, as a saturation index in % SAT or as an oxygen partial pressure in hPa.

Parameters

Model	DM3000	DM2800
Display	2.8-inch monochrome LCD screen, resolution 128*64	
Dimension	Overall dimension: 100mm * 100mm * 150mm Cutout dimension: 92.5mm*92.5mm	
Thickness of the installation panel	1.5mm~13mm	
Weight	0.65kg	
Measuring valuables	DO、 Saturation	DO, Saturation, Oxygen partial pressure
Measuring range	DO:(0~40)mg/L Saturation: 0~130%	DO:(0~20)mg/L Saturation: 0~200% Oxygen partial pressure: (0~400)hPa Temperature:(-10~60) °C
Accuracy	±0.5mg/L	DO/saturation/oxygen partial pressure: ±1.5%F.S
Temperature accuracy	±0.5°C	NTC10K: plus or minus 0.5 °C PT1000: plus or minus 0.5 °C
Output	(4~20)mA output, maximum loop is 750Ω,±0.2%FS	
Communication protocol	Isolated, MODBUS-RTU RS485	
Alarm relay	Pickup/Breakaway AC250V/3A	
Relative humidity	10%RH~85%RH (No condensation)	
Operating temperature	0°C~60°C	
Power supply	AC220V±10%, 5W Max, 50Hz	
Storage conditions	Temperature: -15°C~65°C Relative humidity: 5%~95%RH (No condensation) Altitude:<2000m	
Temperature compensation	NO temp. compensation in controller.but sensors comes with temp. compensation	NTC10K/PT1000 Automatic /Manual temperature compensation
Ingress protection	IP54	

Dimension

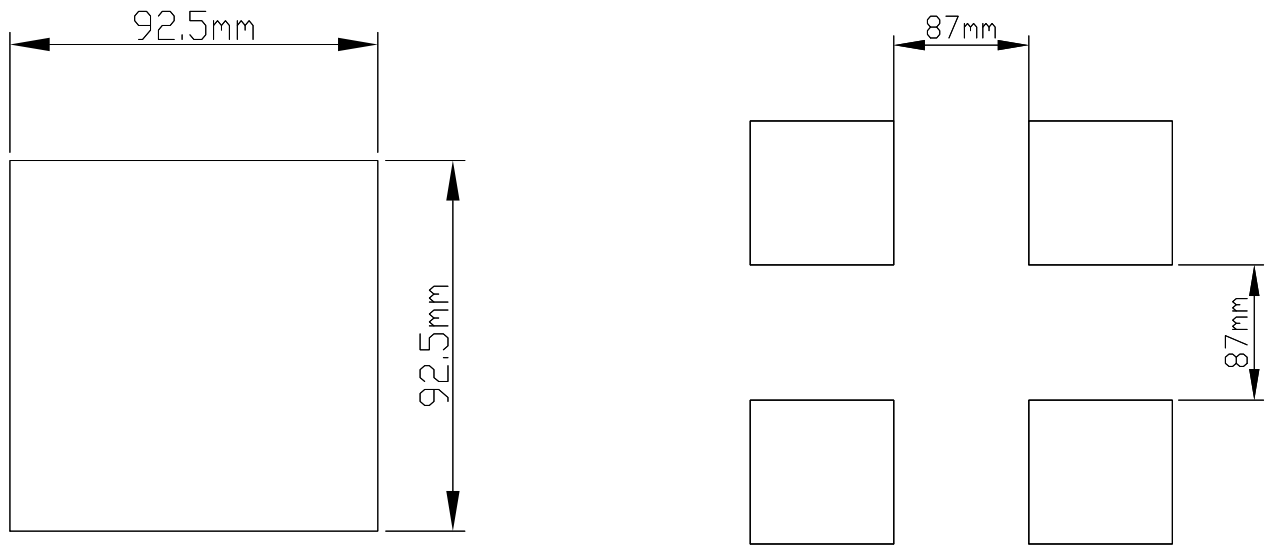

Opening size and minimum distance between square holes of distribution box

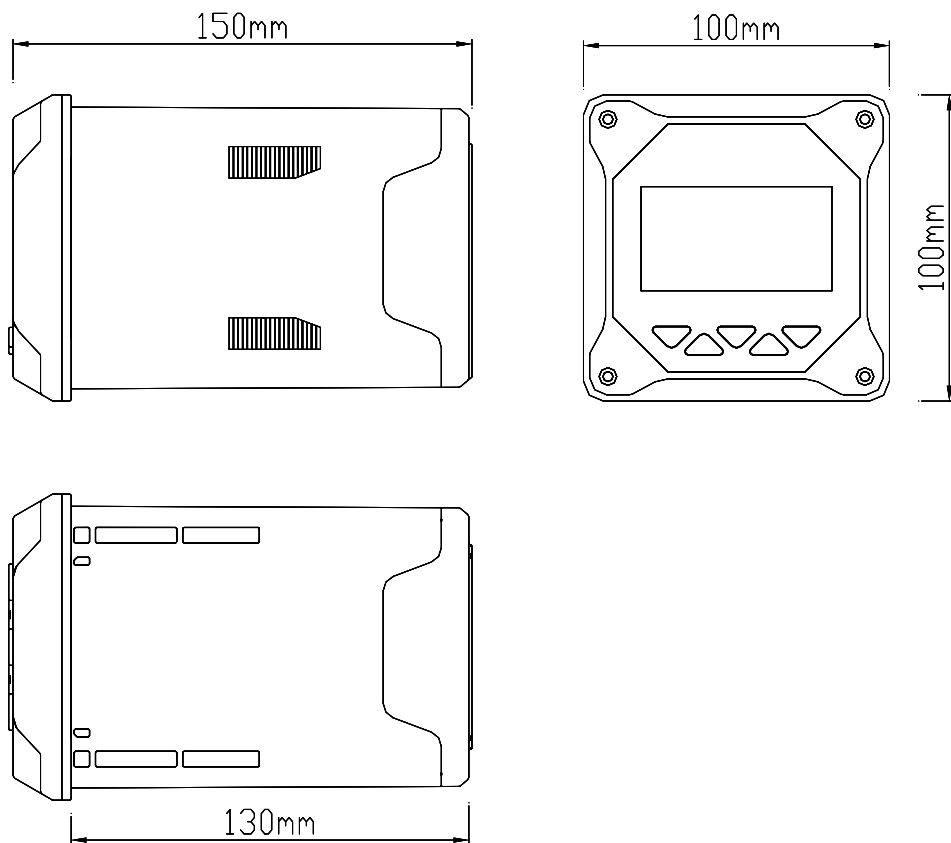

Instrument dimensions

Wiring

- DM3000

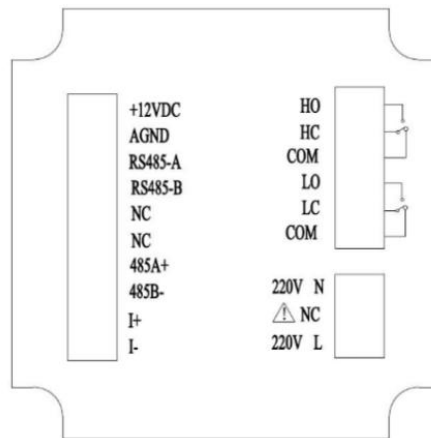

Identification of terminal

- +12VDC: Dissolved oxygen sensor +
- AGND: Dissolved oxygen sensor -
- RS485-A: Dissolved oxygen sensor communication +
- RS485-B: Dissolved oxygen sensor communication -
- NC: Null
- NC: Null
- 485A+: RS485 communication interface A+
- 485B-: RS485 communication interface B -
- I+: 4~20mA output +
- I -: 4~20mA output -
- HO: High alarm normally open
- HC: Low alarm normally closed
- COM: Common terminal
- LO: Low alarm normally open
- LC: Low alarm normally closed
- COM: Common terminal
- 220V L: AC220V live wire
- NC: Null
- 220V N: AC220V neutral wire

- **DM2800**

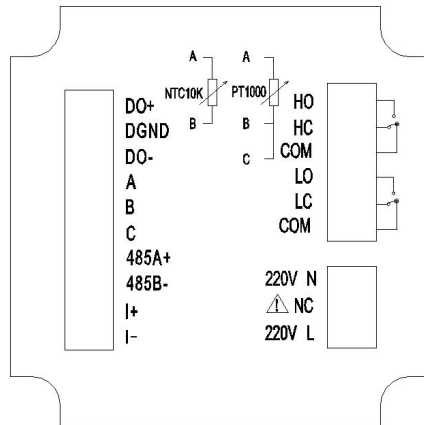

Identification of terminal





- DO+: Dissolved oxygen electrode anode
- DGND: Dissolved oxygen electrode shield wire
- DO-: Dissolved oxygen electrode cathode
- A: Temperature compensation terminal A, NTC10K A or PT1000 A
- B: temperature compensation terminal B, NTC10K B or PT1000 B
- C: Temperature compensation terminal C, short-circuit terminal, PT1000 three-wire system, short-circuit of PT1000 two-wire system to B, NTC10K does not need to be connected to C
- 485A+: RS485 communication output terminal A+
- 485B-: RS485 communication output terminal B-
- I+: (4~20)mA output terminal+
- I-: (4~20)mA output terminal-
- HO: High alarm normally open relay
- HC: High alarm normally closed relay
- COM: Common terminal
- LO: Low alarm normally open relay
- LC: Low alarm normally closed relay
- COM: Common terminal
- 220V N: AC 220V neutral line
- NC: Null
- 220V L: AC 220V live wire

Attention

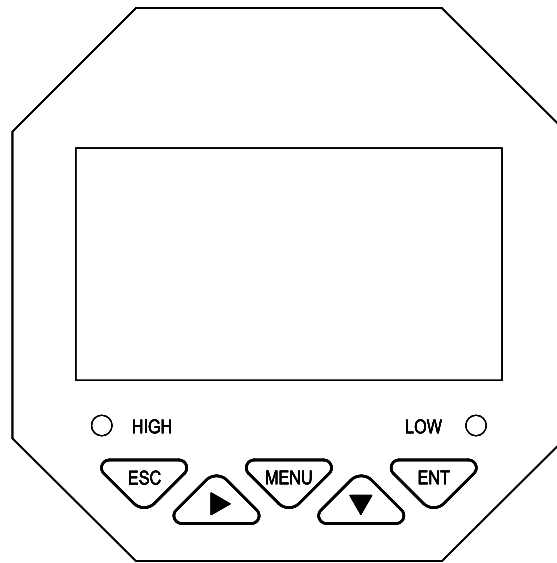
- Confirm that the instrument is not power on before connected with signal wire, to avoid electric shock.
- Use double insulation wire to prevent fire accident.
- Do not put electric product close to signal terminal, which may cause failure.

Display



Sign	Button name	Key function
	EXIT	Enter the menu under "Monitoring Interface" Exit menu under "Menu interface"
	MENU	View related alarm status under "Monitoring Interface" Return to the upper layer between the relevant upper and lower layers of the interface under the "menu interface"
	RIGHT	Cycle through the digits of the selection parameter Toggle "Monitoring Interface"
	DOWN	Select the relevant menu under "Menu interface" Modify the relevant value in the setting state
	ENTER	Enter the submenu under "Menu interface" Confirm the modification under "Menu interface"

Monitor page

★ Dissolved oxygen monitore



DM3000

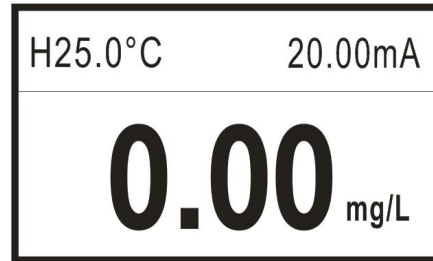

DM2800

★ Saturation monitore

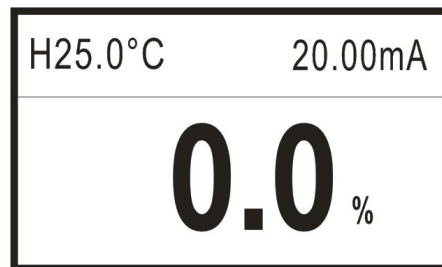

★ Oxygen partial pressure monitore

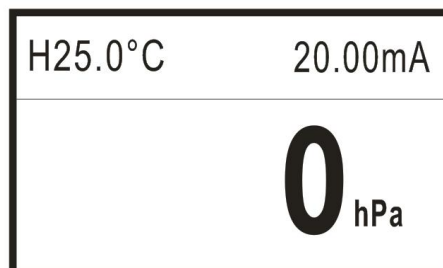

Calibration

Calibration note

- To make a calibration please read the manual carefully before calibration and electrode manual tells completed related to electrode polarization, zero point calibration and calibration notes in the air.
 - For calibration please select % or mg/L . One point calibration suggested the use of % calibration in the air.
 - Making one point calibration, you only need to calibrate the slope of the electrode. Under normal circumstances you can simply make one point calibration.
 - Carry out two-point calibration, calibration in an oxygen-free environment is required for electrode zero point, calibration the slope of the electrode in the oxygen-saturated environment
 - Preparation of oxygen-free water: Configuring 250mL 5% sodium sulphite solution, you can also add a small amount of cobalt chloride as the catalyst.
 - Oxygen-saturated environment: taking distilled water 300~500mL, in relatively stable at an airborne averment at a temperature of at least 30 minutes.
 - The different brands of electrode calibration are slightly different.
-

Maintenance and care

Sensor cleaning

- Please clean and maintain the membrane cap on the sensor regularly according to the actual usage to ensure the accuracy of the measurement. Rinse with clean water first, then wipe with a rag

Sensor damage check

- Check whether the appearance of the sensor is in good condition. If the membrane cap is damaged, please replace the membrane cap with a new one in time or contact the after-sales maintenance department to replace it, so as to prevent inaccurate measurement data of the sensor or internal damage of the sensor due to damage.

Cleaning

- Keep the penetration of electrode interface clean. The application from different cleaning requirements may vary from general industrial waste water has suggested that each 7~15 days use clean water to rinse once.
 - General industrial waste water has suggested that each 30~45 days change filling solution and every 6 months change the membrane once.
-

